



THE WINDOW HUB.CO.UK

SUPPLIED & FITTED BY THE WINDOW HUB

INLINE SLIDING PATIO DOORS

BY DECEUNINCK

deceuninck

Elevate your home with energy-efficient style

www.patiosliders.co.uk



A Seamless Fusion of Style and Functionality

With slimline profiles and expansive glass panels, the TT24 and Slider24 allow an abundance of natural light to flood your living space, creating an atmosphere of openness and tranquility.

Whether you have a stunning garden, a picturesque view, or simply want to create a brighter interior, our sliding patio doors ensure that you won't miss a single moment of the beauty that surrounds you.

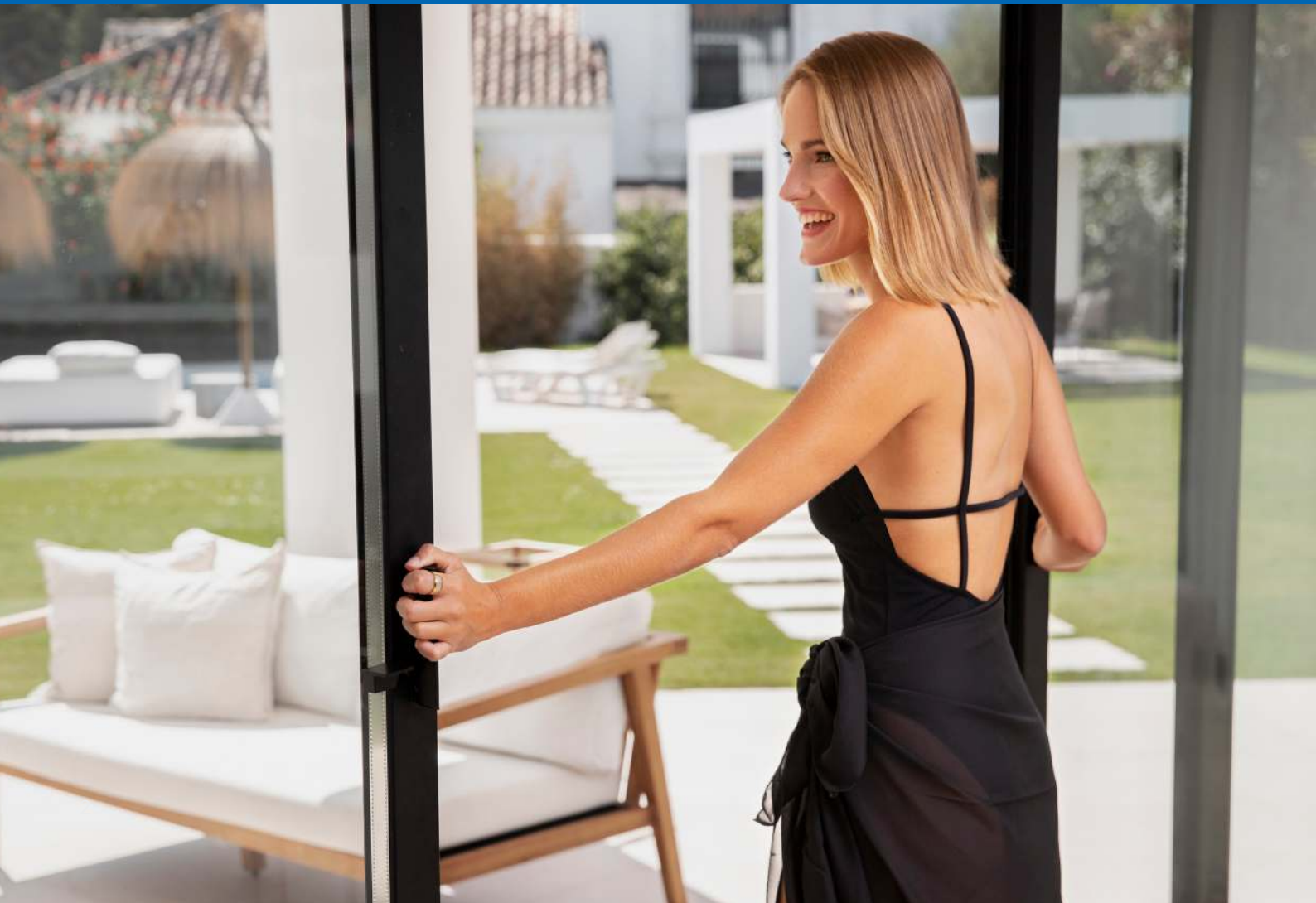

The perfect blend of ENERGY EFFICIENCY & SECURITY



At the heart of the TT24 and Slider24 lies its exceptional energy efficiency.

Crafted with precision and using state-of-the-art technology, this door is built to minimise heat loss and maximise insulation. The multi-chambered profile, combined with high-performance glazing options, creates an effective thermal barrier, reducing energy consumption and lowering heating and cooling costs.

With its impressive U-values, our patio doors ensure that your home remains comfortable throughout the year while reducing your carbon footprint.

Beyond energy efficiency, security is a paramount concern for any homeowner, these sliding doors won't disappoint. Equipped with robust locking mechanisms and reinforced frames, these doors offer unparalleled protection against intruders. The advanced locking systems provide peace of mind, allowing you to relax and enjoy the beauty of your surroundings without compromising on safety.

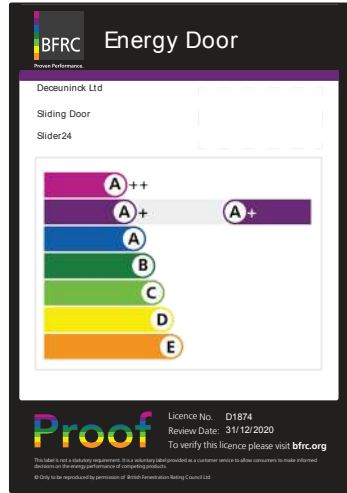

Our sliding Doors are the perfect blend between energy efficiency, security, and aesthetics.

Designed to meet the evolving needs of modern homeowners, these sliding doors are a testament to Deceuninck's commitment to creating products that prioritise both our planet's well-being and our own peace of mind.



SLIDING DOORS WITH ENHANCED SECURITY AND ACCESS

Both TT24 and Slider24 may be specified with full PAS 24 security, making use of a high security sash interlock and locking system to meet the requirements of Approved Document Q as standard.

Standard Lock & Keep Set

- 6 point locking
- Bi-directional hook throw for additional security against jemmying
- Forged brass hooks



PAS24 Corner Drive and Keep Upgrade Kit

- 12 point locking
- Anti-lift device
- PAS24 certified

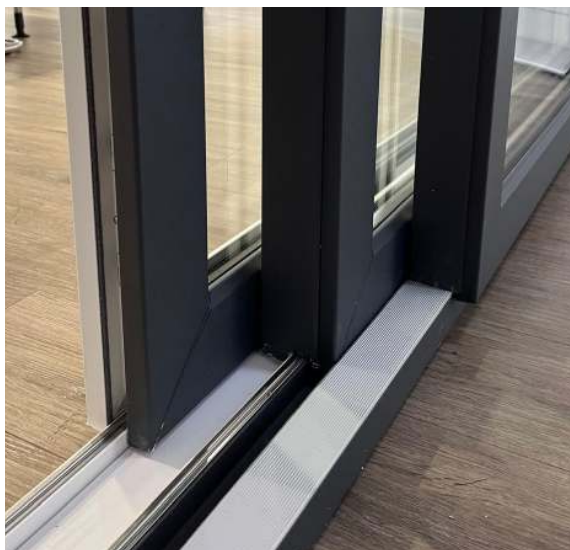

Keep Infill

- Clip-fit aluminium infill for improved aesthetics



Invincible Cylinder

- Reinforced with 5 times more metal than a standard cylinder
- 6 hardened high security pins for the ultimate anti-pick, drill and bump resistance
- Robust shape is a strong visual deterrent
- Independently tested: British Standard Kitemark TS007 and Secured By Design accredited



Pembroke Invincible Handle Set

- Longer lever to ease operation
- Dedicated design to suit Invincible cylinder
- Available in White, Black, Chrome & Graphite



TT24 and Slider24 FOR CONTEMPORARY LIVING



Embrace the spirit of contemporary living with our TT24 & Slider24 doors - The Perfect Doors for Modern Lifestyles



Super Efficient

The TT24 and Slider24 offer excellent insulation qualities which effectively reduce energy and heating costs. They are extremely low maintenance and provide a cost-effective solution to any home improvement project.



Comfortable living

The TT24 and Slider24 provide a host of advantages to the quality of life. The patio door acts as strong and durable insulators against the harsh elements



Sound-Proof

Glazing options to maximise energy efficiency and/or sound proofing.



Safe and Secure

The TT24 and Slider24 provide a secure and protective solution for any home with multi-point locking systems inbuilt to give you peace of mind. The Slider24 is further enhanced with a new sash interlock.





The Triple Track 24 and Slider24 patio door is available in Anthracite Grey, White and 30+ colourways, including Agate Grey on White Woodgrain, Anthracite Grey on White PVC and English Oak on English Oak.

To view our full colour collection, see page 9

TT24 and Slider24

TIMELESS AND CLASSIC

SCULPTURED SASH

The Sculptured sash sliding doors look great in any surrounding; its subtle charm and elegance transforms the building like no other.

- High energy rating and weather performance
- Enhanced security PAS24 Approved
- Double or triple glazing available
- Low maintenance PVC-u frames
- Available in 30+ colourways from stock
- 10 Year guarantee



CHAMFERED SASH

The beautiful Chamfered shape adds a stylish elegance to our sliding Patio Doors. The Chamfered contours integrate easily in all types of architecture and design with a range of colours and finishes that ensure you can find the perfect window for your home.

- High energy rating and weather performance
- Enhanced security PAS24 Approved
- Double or triple glazing available
- Low maintenance PVC-u frames
- Available in 30+ colourways from stock
- 10 Year guarantee

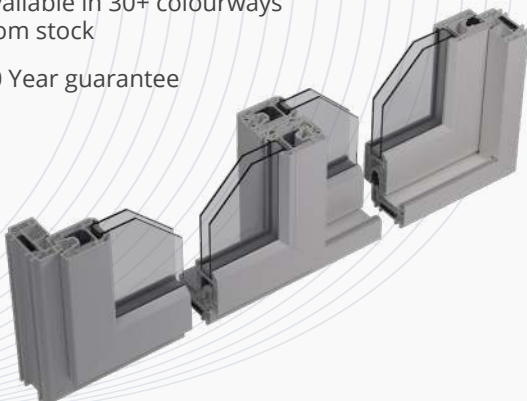

TRIPLE TRACK 24

- TT24 is a next generation sliding patio door from Deceuninck – incorporating high quality hardware it combines superb aesthetics with a smooth opening and outstanding performance
- Certified to PAS24:2022 enhanced security for two, three, four and six panes
- Complete with 8-point locking mechanism and an ERA total security guarantee, it can be manufactured to a maximum width of 6m
- TT24 can withstand heavy loads and has market leading weather performance, air and water tightness
- With a double-glazed A+ WER energy rating, TT24 also offers excellent energy performance
- TT24 suites with Deceuninck's 2800 system
- Air class 3, Wind class B3 & Water Class 7A can be achieved
- Available in 30+ colourways from stock
- 10 Year guarantee



Transform your living space with the timeless beauty of our Heritage Colour Collection

Ask your supplier for details and bring a touch of nature's beauty into your home today!

Carefully curated to help you create the ideal palette for your home, this collection takes inspiration from nature's hues to seamlessly integrate into your surroundings.

Whether you prefer warm and inviting or cool and contemporary, our range of woodgrain foil and solid colours offers a variety of options to suit your style.



Weather Resistant

Best in class weather performance, air and water tightness.



Extremely Durable

Crafted from high-quality PVC, our sliding patio doors boast exceptional durability, capable of withstanding even the harshest weather conditions.



10 Year Guarantee

For your complete peace of mind, we provide a manufacturer's guarantee of a minimum of 10 years on our TT24 and Slider24 patio doors.



Colour Match

Each of our Heritage colours has its own matching ancillaries, trims and accessories for your TT24 and Slider24 and matching windows from our Heritage range.



30+ Colourways

We take pride in offering a wide selection of colour options for our products, with over 30 different colourways available from stock

TT24 and Slider24

30+ COLOURWAYS IN STOCK

A unique range of woodgrain foil colours in 30+ colourways in stock, complete with matching ancillaries, trims and accessories.

Heritage Colour Range - Surcharge applies.



ANTHRACITE SMOOTH /
HERITAGE WHITE



BLACK ASH /
HERITAGE WHITE



AGATE GREY /
HERITAGE WHITE



ENGLISH OAK /
HERITAGE WHITE



ENGLISH OAK
BOTH SIDES



HERITAGE WHITE /
ENGLISH OAK



ICE CREAM /
HERITAGE WHITE



HERITAGE WHITE
BOTH SIDES



GREY ALUMINIUM /
WHITE PVC



ANTHRACITE SMOOTH
MATT / WHITE PVC

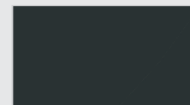

ANTHRACITE SMOOTH
MATT BOTH SIDES



ANTHRACITE GRAINED /
WHITE PVC

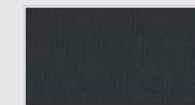

ANTHRACITE GRAINED
BOTH SIDES



ROSEWOOD /
WHITE PVC



ROSEWOOD
BOTH SIDES



NUT TREE /
WHITE PVC

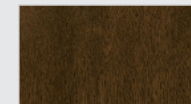

NUT TREE BOTH SIDES



BLACK SMOOTH MATT /
WHITE PVC



BLACK ASH /
WHITE PVC



BLACK ASH
BOTH SIDES



GOLDEN OAK /
WHITE PVC



GOLDEN OAK
BOTH SIDES



IRISH OAK / WHITE PVC



IRISH OAK BOTH SIDES



CHARTWELL GREEN /
WHITE PVC



CHARTWELL GREEN
BOTH SIDES



CLASSIC CREAM /
WHITE PVC



CLASSIC CREAM
BOTH SIDES



WHITE GRAIN /
WHITE PVC



WHITE GRAIN
BOTH SIDES



AGATE GREY /
WHITE PVC





Security Guarantee
Recognised by Neighbourhood Watch



CONFIGURATIONS

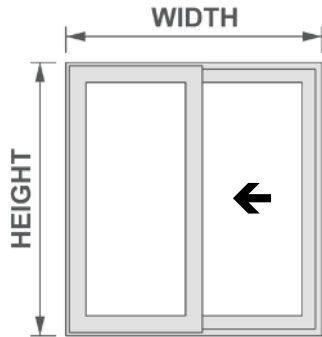

Slider 24 - 2 pane

Maximum Frame Size (mm)	
Width	Height
2700	2250

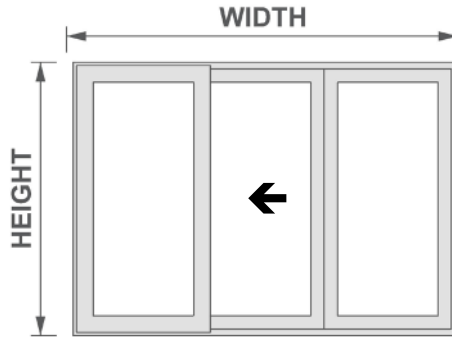

Slider 24 - 3 pane (central slider)

Maximum Frame Size (mm)	
Width	Height
4600	2250

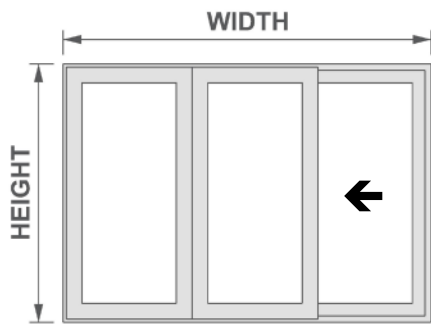

Slider 24 - 3 pane (end slider)

Maximum Frame Size (mm)	
Width	Height
4500	2400

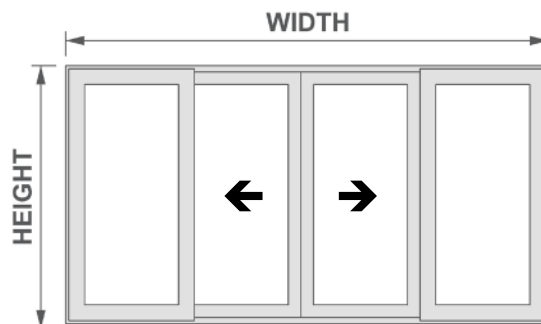

Slider 24 - 4 pane

Maximum Frame Size (mm)	
Width	Height
5900	2400

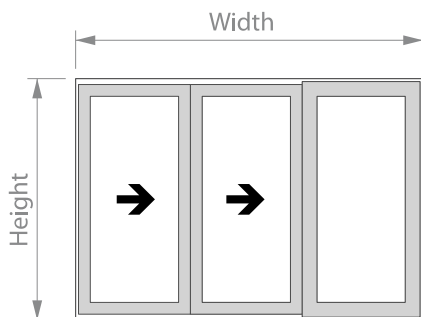

TT24 - 3 pane

Maximum Frame Size (mm)	
Width	Height
4420	2250

(2280mm with cill)

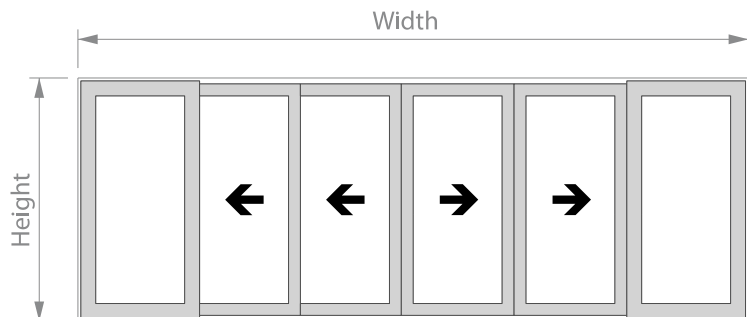

TT24 - 6 pane

Maximum Frame Size (mm)	
Width	Height
6000	2250

(2280mm with cill)



deceuninck

BUILDING A
SUSTAINABLE HOME

BUILDING A SUSTAINABLE HOME

Through innovative designs and production processes we deliver the most sustainable window, door and building solutions for today's and tomorrow's customers.

YOUR LOCAL DECEUNINCK DEALER



G25 National Installer of the Year

Bristol: 0117 313 4862 • Exeter: 01392 642 634 • Cardiff: 02922 946891

Freephone: 08000 219 319

www.thewindowhub.co.uk

Bristol Showroom: 72-74 High Street, Staple Hill, BS16 5HN

Exeter Showroom: 208 Topsham Road, EX2 6AA

Cardiff Office: Cardiff Gate Business Park, CF23 8RU

15-year guarantee on all installations • FENSA Registered (39576)

deceuninck

Deceuninck Limited · Stanier Road · Porte Marsh · Calne · Wiltshire SN11 9PX
T +44 (0)1249 816 969 · deceuninck.ltd@deceuninck.com · www.deceuninck.co.uk

